

65101-11792-C

Read the instruction before operating your shade

Installation & Maintenance Instructions
Honeycomb Shade
Decoflex™ / Decoflex™ Day & Night

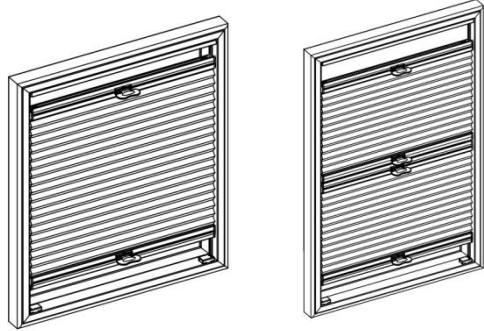

Getting Started



Remove the shade from the package. Save the packaging until the shade is installed and working to your satisfaction.

Recommended Tools

- Power drill and drill bit
- Measuring tape
- Screwdriver
- Level
- Pencil

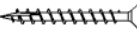

You will need to use the following fasteners for your particular mounting surfaces:

Surface	Fastener
Wood	Screws 
Drywall/Plaster	Wall Anchors, Expansion Bolts (Not Provided) 
Metal	Sheet Metal Screws (Not Provided) 

Check Hardware

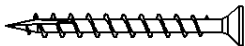

Screw

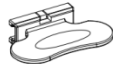

Handle

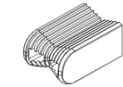

Dovetail Key

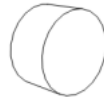

Wood Plug (optional for IM)

Step 1. Assemble the Frame

When OM, take off frame insert from the frame first, No need to take off frame insert for IM.

And then assemble the frame together with Dovetail Key at the back of the frame.

Frame with T-post, assemble the frames together first, and then connect the T-post with frame before installing the frame on the window opening.

4 sided Frame:

When OM, take off the frame insert

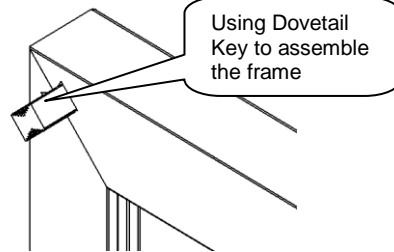
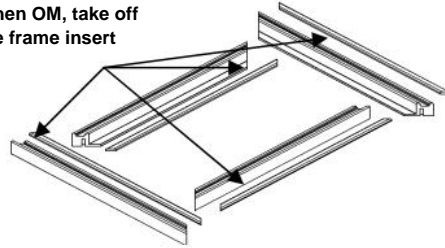

Using Dovetail Key to assemble the frame

Frame with T-Post (optional for all Frames, except Hang Strip IM)

L Frame with T-Post

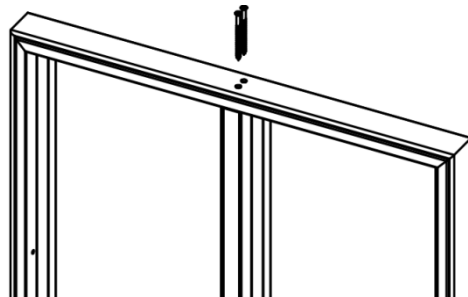

Z Frame with T-Post

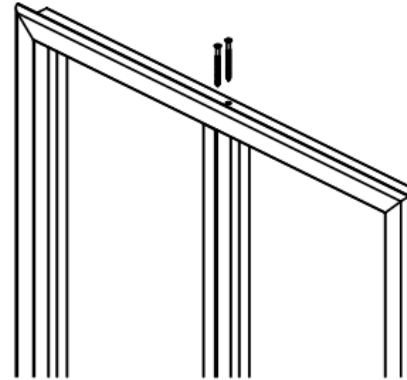

Front View

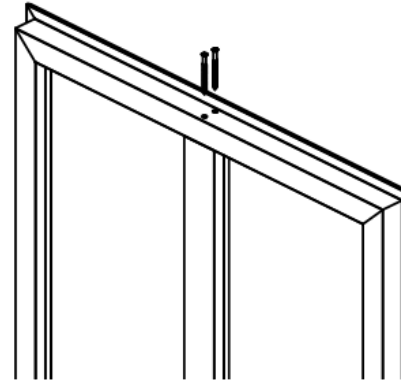

Back View

Deco Frame with T-Post

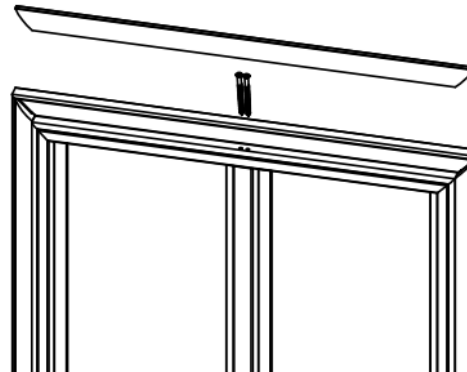

Step 2. Install the Frame

Outside Mount

Place the shade in desired position, and fix the left-side frame and right-side frame with one screw respectively.

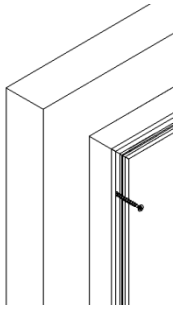

And then adjust the frame to make sure the frame is square and the diagonal line is in the same length. Secure the rest screws after adjusting the frame to square.

After all screws are secured, re-attached the frame insert to the frame.

Inside Mount (when pre-drill option is selected)

Place the shade in desired position, and fix the left-side frame and right-side frame with one screw respectively.

Then adjust the frame to make sure the frame is square and diagonal line is in the same length. Secure the rest screws after adjusting the frame to square. And attach the wood plug into each screw hole.

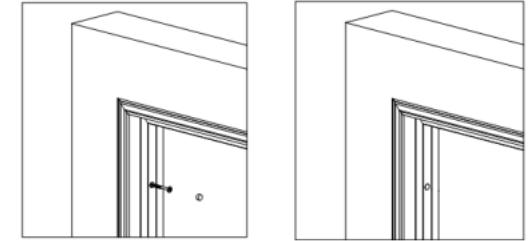

Note: For IM, pre-drill frame for easy installation is optional. Mounting screws & wood plugs will be supplied when pre-drill option is selected.

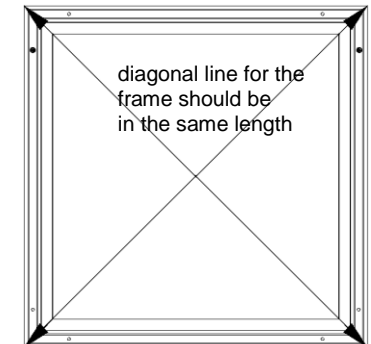

diagonal line for the frame should be in the same length

Step3. Install the Shade

Install the shoe slider onto shoe Base which is pre-installed on the frame, by pushing down the Cover from top of the notch then slide to the side to match the Base. Make sure that cords are nice, tight and not tangled.

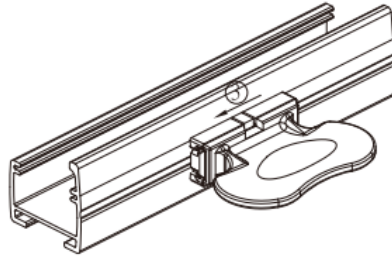
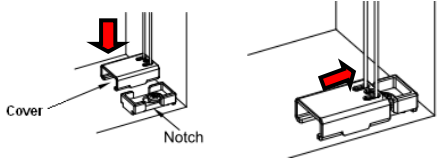

For child safety, please check and ensure that there are no loose cords after the shade is completely installed.

For SmartFit™

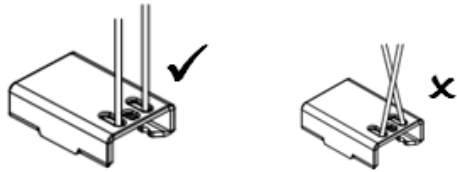

For SmartFit™ Day & Night

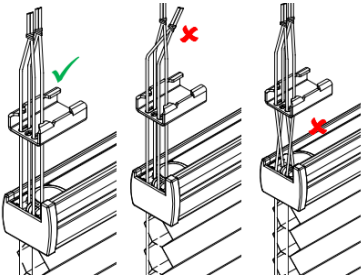

Please also make sure that cords are nice and tight and not tangled.

Step4. Handle Installation

Attach the handle to the handle support pre-attached on the rail then slide against the handle support to the left until the handle can't move anymore.

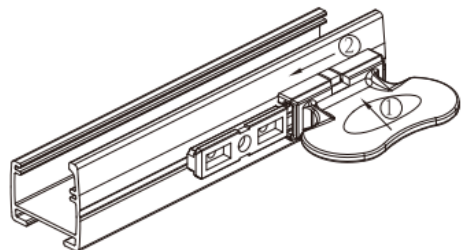

Step5. Adjust the Shade

After the shade is completely installed, use the handle to raise the shade up to the top and adjust the shade to level. Then you may operate the shade to any desired position.

Step6. Remove the Shade

Operate the shade to the middle from top and bottom. Remove the shoe slider from the shoe Base.

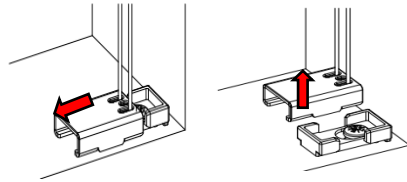

Cleaning Instructions

Routine cleaning will help maintain the beauty of your shade. The shade can be cleaned by using a soft brush, vacuumed with a low suction hand-held vacuum, cleaned ultrasonically (specify that a mild solution must be used and that the head rail should never be immersed in liquid), or dampen a clean cloth with a warm water and mild detergent solution to dab the spot until it's gone (do not rub!).

**** For all frames: the installation way is the same, no matter what frame is ordered.**

Vintage L Frame with valance insert

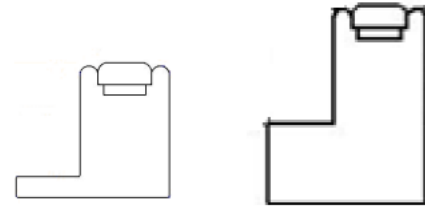

With 5mm light block With 19mm light block

50mm Camber Deco Frame

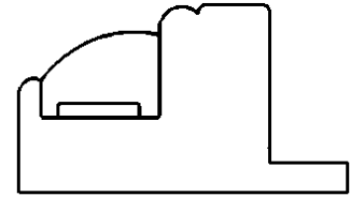

Hang Strip

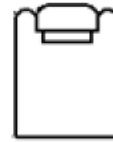

Beaded L Frame

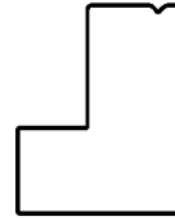

50mm Classic Deco Frame

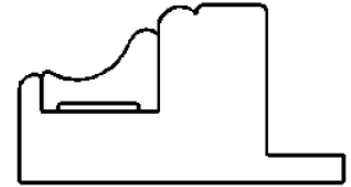

32mm Beaded Z Frame

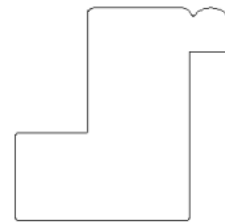

38mm Bullnose Z frame

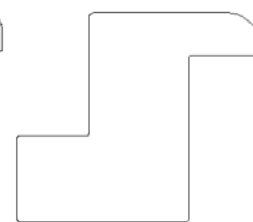

76mm Crown Z Frame

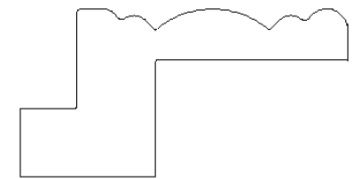

50mm Bel Air Z frame

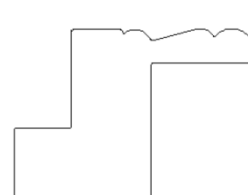

50mm Bullnose Z Frame

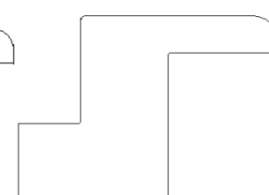

76mm Ridge Deco Frame

